

# ELEMENT™ PLUS SMALL

RECESSED

TYPE:

PROJECT NAME:

## ORDERING INFO

Model	Housing	Output	LED	Optic	Voltage	Finish	Dimming
<input type="radio"/> L46521: Square, fixed, with trim	<i>See below</i>	<input type="radio"/> 11W	<input type="radio"/> 27K (2700K)	<input type="radio"/> Fixed Spot (20°)	<input type="radio"/> 120V	<i>See below</i>	<input type="radio"/> LTE (Leading/ Trailing Edge Dim)
<input type="radio"/> L46511: Round, fixed, with trim		<input type="radio"/> 15W	<input type="radio"/> 30K (3000K)	<input type="radio"/> Fixed Flood (40°)	<input type="radio"/> 277V		
<input type="radio"/> L46522: Square, adjust., with trim		<input type="radio"/> 20W	<input type="radio"/> 35K (3500K)	<input type="radio"/> Adjustable Spot (20°)			
<input type="radio"/> L46512: Round, adjust., with trim			<input type="radio"/> 40K (4000K)	<input type="radio"/> Adjustable Flood (40°)			
<input type="radio"/> L46541: Square, fixed, trimless*							<input type="radio"/> 010V (0-10V)
<input type="radio"/> L46531: Round, fixed, trimless*							
<input type="radio"/> L46542: Square, adjust., trimless*							
<input type="radio"/> L46532: Round, adjust., trimless*							

\*Trimless models must be ordered with trimless finish option

## HOUSING OPTION

Housing

- RF: Retrofit (no housing)
- NC: New construction plaster frame
- IC: Insulated ceiling housing
- CP: Chicago plenum housing

## FINISH OPTION

Finish  
First color indicates trim,  
second indicates reflector

### White Trim Options

- 01: White/White
- 21: White/Black
- 41: White/Gold
- 13: White/Aluminum

### Black Trim Options

- 23: Black/White
- 02: Black/Black
- 42: Black/Gold
- 33: Black/Aluminum

### Grey Trim Options

- 20: Grey/White
- 22: Grey/Black
- 40: Gray/Gold
- 03: Gray/Aluminum

### Trimless Options

- 01: Trimless/White
- 02: Trimless/Black
- 43: Trimless/Gold
- 51: Trimless/Aluminum

Fixed, With Trim

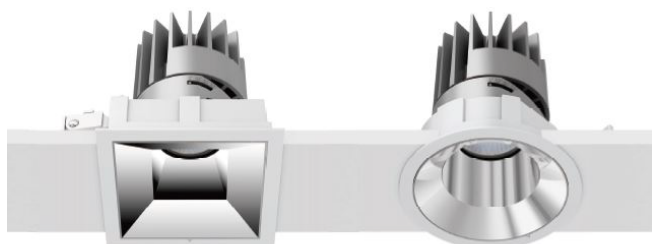

Adjustable, With Trim

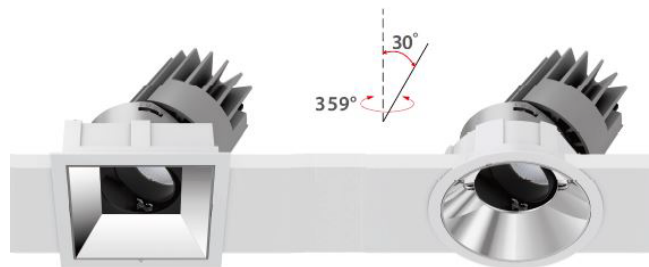

Fixed, Trimless

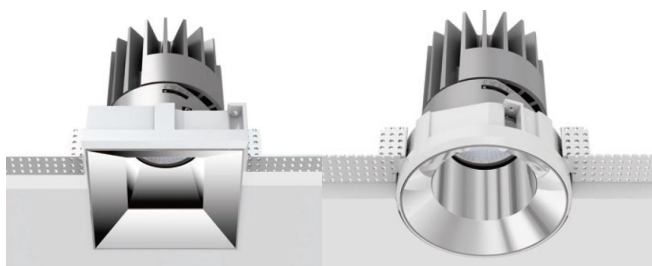

Adjustable, Trimless

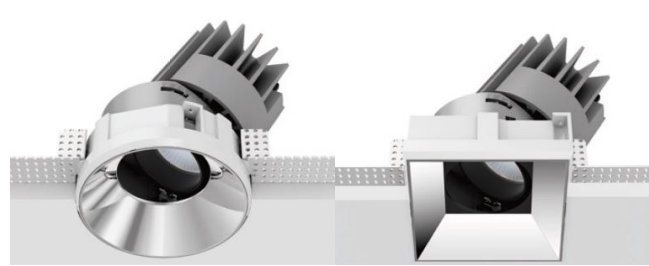

SPECIFICATION SHEET

LEDOLOGY®

WWW.LEDOLOGY.COM

A Luminart® BRAND

# ELEMENT™ PLUS SMALL

RECESSED

TYPE:

PROJECT NAME:

## GENERAL INFO

Specification grade downlights for architectural applications, with build quality and features for professional applications. 4" aperture.

### Luminaire characteristics:

Power input: 11W, 15W or 20.5W

Lumens: 600, 800 or 1100lm (for 3000K, 80CRI) Luminaire efficacy: Up to 66lm/W

### Source:

COB LED module (LM-80 tested)

2700K : 90CRI or 97CRI,

3000K : 80CRI, 90CRI, or 97CRI,

3500K : 80CRI or 90CRI,

4000K : 80CRI.

### Lumen maintenance:

LM79 tested,

90% of initial lumens at 50 000 hours (L90), 80% of initial lumens at 100 000 hours (L80).

### Optic:

Fixed: Deep recessed reflector available with spot or flood optic.

Adjustable: Deep recessed reflector available with spot or flood optic. Optical assembly hot aiming adjustment: 30° tilt and 359° pan.

### Material:

Body: Die-cast aluminum optical assembly

Reflector: Metalized polycarbonate

Baffle: Painted polycarbonate

### Mounting:

See housing options, page 1. For detailed information see page 5.

### Electrical:

Integral high efficiency power supply rated at 50 000 hours, 120V or 277V.

### Dimming:

Leading edge (triac), Trailing edge (elv) and 0-10V down to 15%

0-10V down to 1%

### Finish:

Powder coated body and baffle. See finish options, page 1.

### Weight:

2.55lbs (1.16kg)

### Warranty:

5 year limited warranty

### Rating:

IP54

### Certification:

cULus listed for Damp location.

SPECIFICATION SHEET

LEDOLOGY®

WWW.LEDOLOGY.COM

A **Luminart** BRAND

# ELEMENT™ PLUS SMALL

RECESSED

TYPE:

PROJECT NAME:

46521: Square, Fixed, With Trim

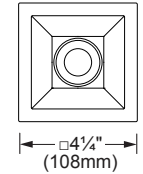
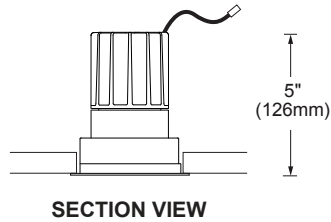
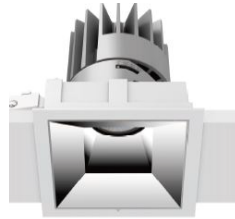

SECTION VIEW

BOTTOM VIEW

46511: Round, Fixed, With Trim

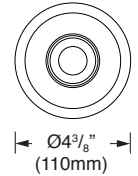
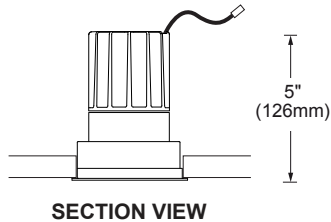

SECTION VIEW

BOTTOM VIEW

46541: Square, Fixed, Trimless

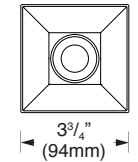
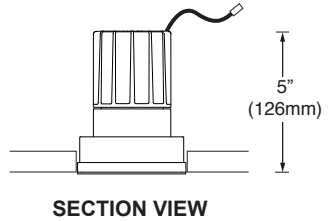
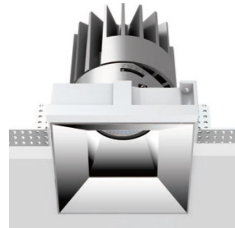

SECTION VIEW

BOTTOM VIEW

46531: Round, Fixed, Trimless

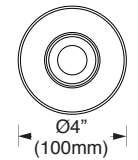
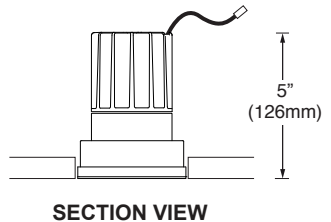

SECTION VIEW

BOTTOM VIEW

## PHOTOMETRIC DATA

FIXED

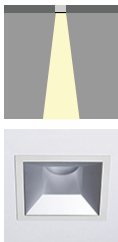

CCT (K)	CRI	OUTPUT	LOAD (W)	OPTIC	LUMENS (lm)	EFFICACY (lm / w)	MAX CANDELA (cd)
3000K	80	HE	11W	Spot	710	64	2 980
				Flood	540	49	1 240
		BO	15W	Spot	990	66	5 595
				Flood	755	50	1 720
		HO	20.5W	Spot	1340	65	7 420
				Flood	1020	49	2 325

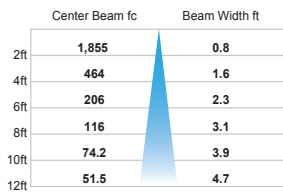

20.5W - 3000K - 80 CRI - Spot 20°

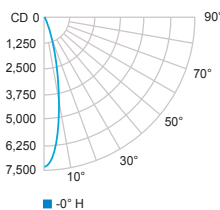

■ -0° H

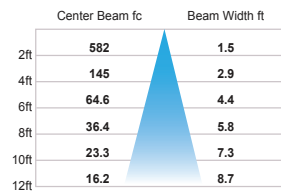

20.5W - 3000K - 80 CRI - Flood 40°

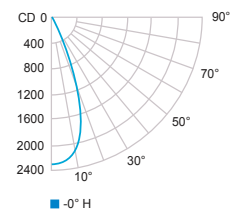

■ -0° H

SPECIFICATION SHEET

LEDODOLOGY®

WWW.LEDOLOGY.COM

A Luminart® BRAND

# ELEMENT™ PLUS SMALL

TYPE:

RECESSED

PROJECT NAME:

46522: Square, Adjustable, With Trim

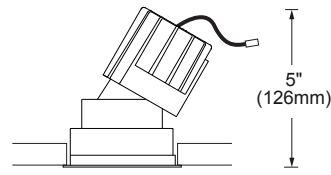

SECTION VIEW

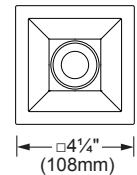

BOTTOM VIEW

46512: Round, Adjustable, With Trim

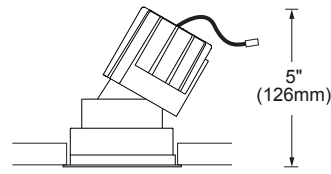

SECTION VIEW



BOTTOM VIEW

46542: Square, Adjustable, Trimless

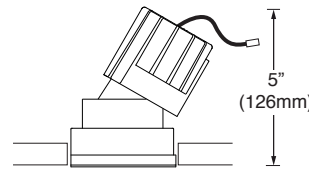
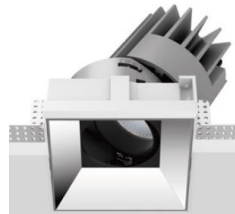

SECTION VIEW

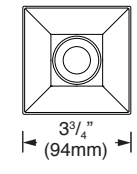

BOTTOM VIEW

46532: Round, Adjustable, Trimless

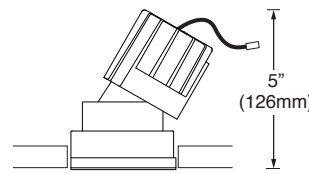

SECTION VIEW

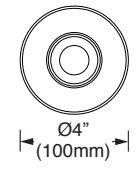

BOTTOM VIEW

## PHOTOMETRIC DATA

CCT (K)	CRI	OUTPUT	LOAD (W)	OPTIC	LUMENS (lm)	EFFICACY (lm / w)	MAX CANDELA (cd)
3000K	80	HE	11W	Spot	710	64	2 980
				Flood	540	49	1 240
		BO	15W	Spot	990	66	5 595
				Flood	755	50	1 720
		HO	20.5W	Spot	1340	65	7 420
				Flood	1020	49	2 325

ADJUSTABLE



SPECIFICATION SHEET

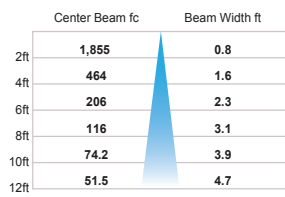

20.5W - 3000K - 80 CRI - Spot 20°

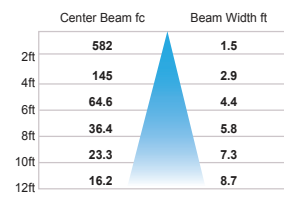
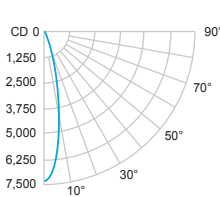

20.5W - 3000K - 80 CRI - Flood 40°

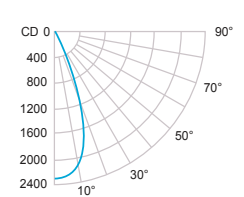

LEDODOLOGY®

WWW.LEDOLOGY.COM

A Luminart BRAND

# ELEMENT™ PLUS SMALL

RECESSED

TYPE:

PROJECT NAME:

## RT: Retrofit

For new or existing ceiling. Suitable for non-insulated ceiling like sheetrock or paneling. Trimless frame kit can be shipped separately.

**Minimum ceiling clearance:** 6½" (165mm)

**Ceiling thickness:** ¼" to ⅞" (3mm - 22mm)

**Total weight:** 2.55lbs (1.16kg)

### Cut-out:

Round: Trim: Ø 4" (Ø 100mm)

Trimless: Ø 4⅞" (Ø 105mm)

Square: Trim: 3⅞" x 3⅞" (97 x 97mm)

Trimless: 4" x 4" (100 x 100mm)

### Trimless frame kit codes:

Round: RT-S-R-TL

Square: RT-S-S-TL

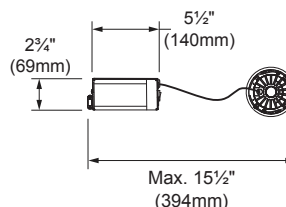
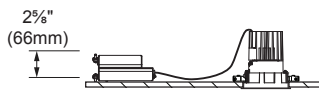

## NC: New construction with plaster frame

Plaster frame with hanger bars system to be installed during rough-in phase. Suitable for non-insulated new construction ceiling assemblies, like sheetrock, acoustic tiles, or paneling. Plaster frame and trimless frame kit can be shipped separately.

**Minimum ceiling clearance:** 6½" (165mm)

**Ceiling thickness:** ¼" to ⅞" (3mm - 22mm)

**Total weight:** 3.75lbs (1.7kg)

### Cut-out:

Round: Trim: Ø 4" (Ø 100mm)

Trimless: Ø 4⅞" (Ø 105mm)

Square: Trim: 3⅞" x 3⅞" (97 x 97mm)

Trimless: 4" x 4" (100 x 100mm)

### Plaster frame codes:

Round: Trim: NC-S-RT

Trimless: NC-S-RTL

Square: Trim: NC-S-ST

Trimless: NC-S-STL

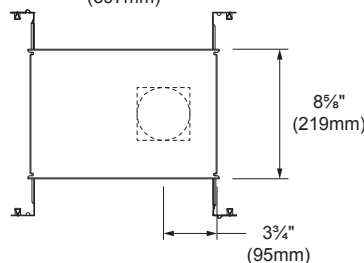
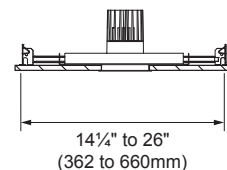
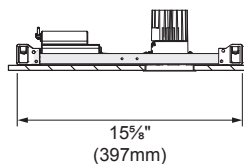

## IC: New construction with housing suitable for insulated ceiling or Chicago plenum

Housing with hanger bars system for new construction installations. Suitable for insulated ceiling or Chicago Plenum applications. Housing and trimless frame kit can be shipped separately.

**Minimum ceiling clearance:** 6¾" (171mm)

**Ceiling thickness:** ¼" to ⅞" (3mm - 22mm)

**Total weight:** 10.2lbs (4.63kg)

### Cut-out:

Round: Trim: Ø 4" (Ø 100mm)

Trimless: Ø 4⅞" (Ø 105mm)

Square: Trim: 3⅞" x 3⅞" (97 x 97mm)

Trimless: 4" x 4" (100 x 100mm)

### Housing codes:

Round: Trim: IC-S-RT

Trimless: IC-S-RTL

Square: Trim: IC-S-ST

Trimless: IC-S-STL

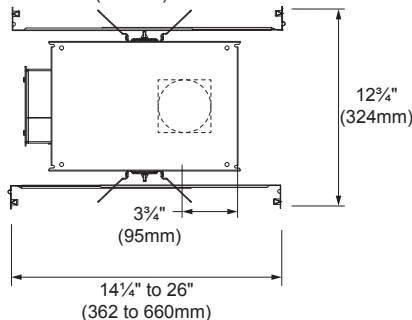
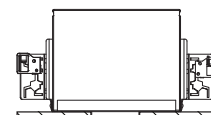
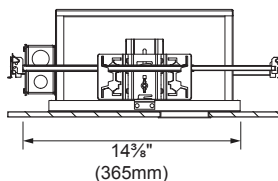

SPECIFICATION SHEET

LEDOLOGY®

WWW.LEDOLOGY.COM

A Luminart BRAND