

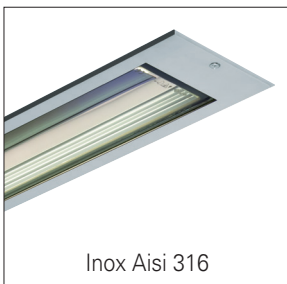

LINE



Inox Aisi 316

- Extruded aluminium body 6060T5
- Closing terminal in die-cast aluminium ENAB46100
- Aluminium flask with millimetric regulation
- Painted with polyester powders certified Qualicoat® previous treatment of sandblast process and hexavalent chrome free passivation
- Tempered glass diffuser
- Closing screws in stainless steel A4
- Epdm rubber gaskets
- Lamp not included
- IP67.
- Class I
- CE omologations

LINE™ Downlight

TYPE:

PROJECT NAME:







Intertek



MODEL # FINISH LED COLOR OPTIC DRIVER VOLTAGE

Configuration code
L223002 + .1 + .01 + .18

Finishing



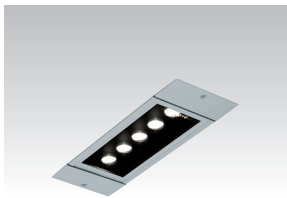

-  .01 Frosted glass
-  .1 Anthracite
-  .4 Grey (Ral 9006)
-  .18 Inox ring (Aisi 316)

Accessories

-  **L22104** Connector IP68
-  **L2298** Asymmetric reflector (F.3002)
-  **L2299** Asymmetric reflector (F.3003)





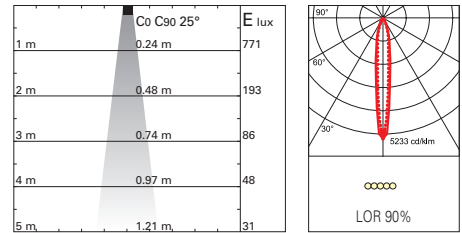

L223000
Ceiling

6w 302 lumen
4000°K CRI 80
120-277V 50/60Hz
IP67  







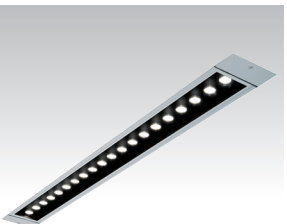
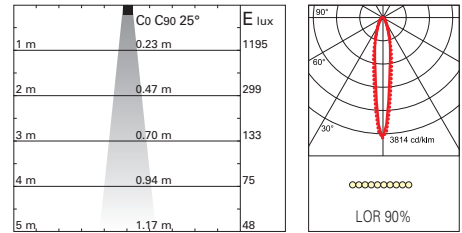

L223001
Ceiling

12w 640 lumen
4000°K CRI 80
120-277V 50/60Hz
IP67  





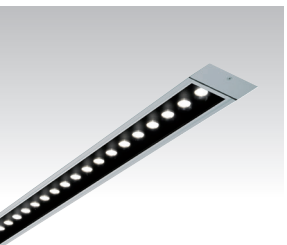
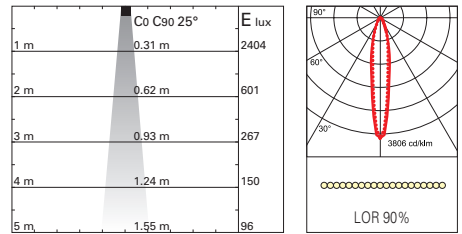

L223014
Ceiling

24w 1310 lumen
4000°K CRI 80
120-277V 50/60Hz
IP67  





L223015
Ceiling

30w 1650 lumen
4000°K CRI 80
120-277V 50/60Hz
IP67  

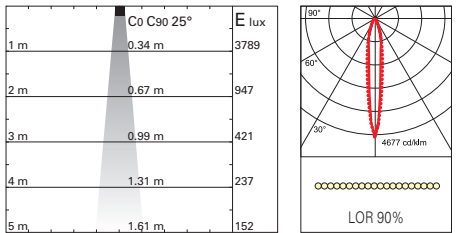



SPECIFICATION SHEET

LINE™ Downlight LED

TYPE:

PROJECT NAME:

L223000

MODEL #

FINISH

LED COLOR

OPTIC

DRIVER

VOLTAGE

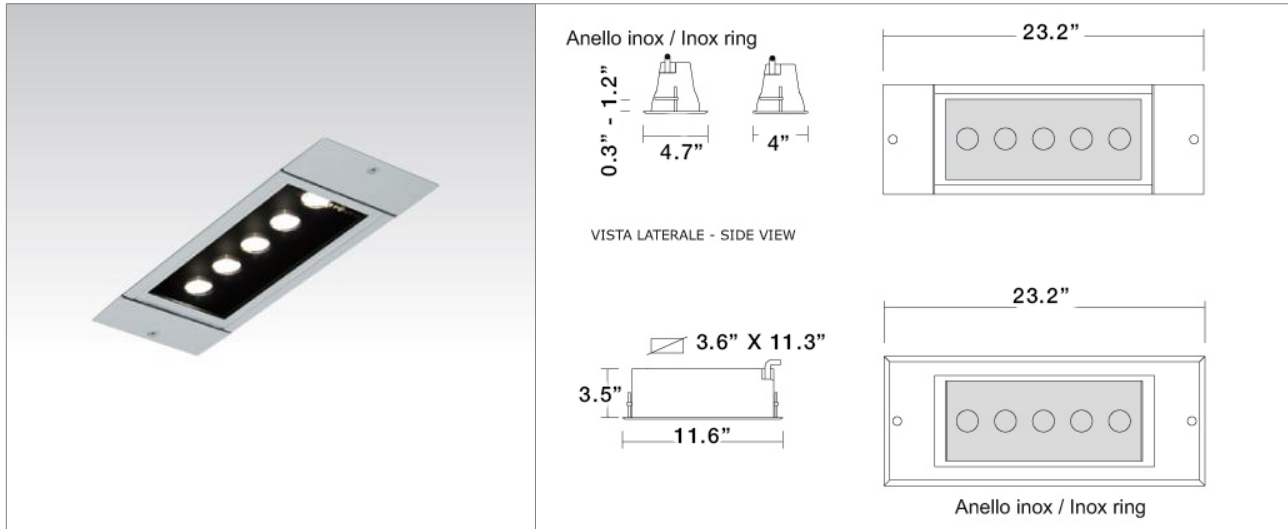

SPECIFICATION SHEET

Housing:

Extruded aluminium body 6060T5, Die-cast aluminium ring with high oxidation resistance ENAB 44300, Aluminium fixing flasks..

Diffuser:

Transparent tempered glass diffuser (on request frosted glass)

Closing screws:

Screws in stainless steel A4

Rubber gasket:

Epdm rubber gaskets

Wiring:

Brass cable blocker IP68 for cable \varnothing 7-10mm.

Installation:

Downlight.

Weight:

1.30 Kg

Finish:

.1 anthracite, .4 grey aluminium

Accessories:

L22104 connector IP68.

LED Driver Voltage Option:

120 - 277V

SOURCE DESCRIPTION

LED Options:

.27 4000°K .28 3000°K. .29 6000°K. .31 beam 10° .32 beam 40° .EL beam elliptical

CRI:

CRI 85

Rated luminous flux:

Lighting flow: 301 lumen. Total absorbed power 7w.

CERTIFICATIONS

Normative:

EN60598 and relative specifications

Certification:

ETL

Protection Class:

IP67-IK08 (versions with inox ring IK09)

SPECIFICATION SHEET

LINE™ Downlight LED

TYPE:

PROJECT NAME:

L223001

MODEL #

FINISH

LED COLOR

OPTIC

DRIVER

VOLTAGE

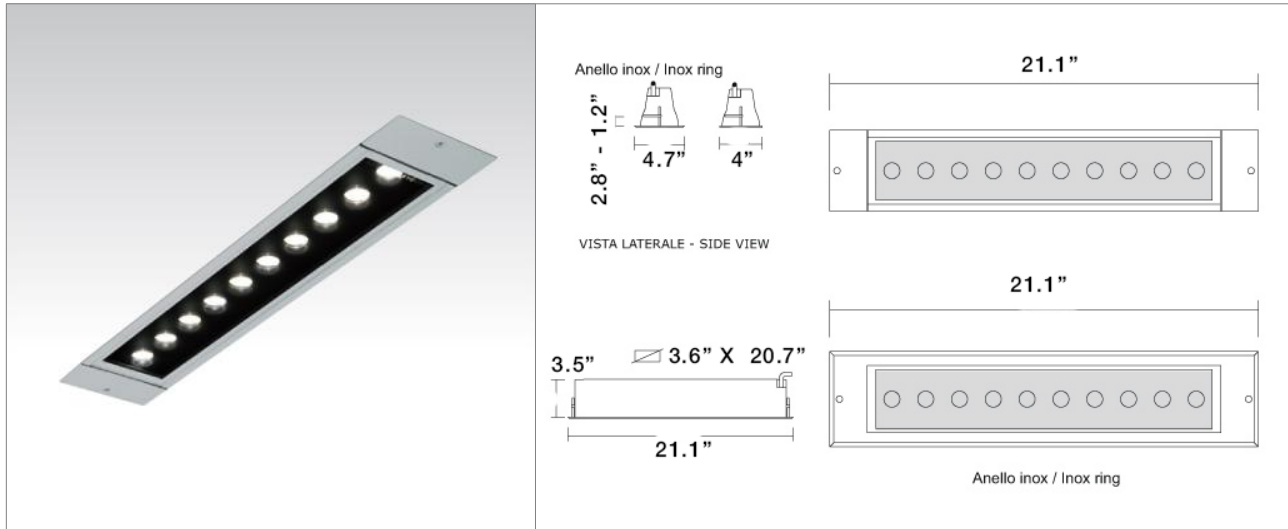

SPECIFICATION SHEET

Housing:

Extruded aluminium body 6060T5, Die-cast aluminium ring with high oxidation resistance ENAB 44300, Aluminium fixing flasks..

Diffuser:

Transparent tempered glass diffuser (on request frosted glass)

Closing screws:

Screws in stainless steel A4

Rubber gasket:

Epdm rubber gaskets

Wiring:

Brass cable blocker IP68 for cable @7-10mm.

Installation:

Downlight.

Weight:

2.20 kg

Finish:

.1 anthracite, .4 grey aluminium

Accessories:

L22104 connector IP68.

LED Driver Voltage Option:

120 - 277V

SOURCE DESCRIPTION

LED Options:

.27 4000°K .28 3000°K. .29 6000°K. .31 beam 10° .32 beam 40° .EL beam elliptical

CRI:

CRI 85

Rated luminous flux:

Lighting flow: 640 lumen. Total absorbed power 13w.

CERTIFICATIONS

Normative:

EN60598 and relative specifications

Certification:

ETL

Protection Class:

IP67-IK08 (versions with inox ring IK09)

SPECIFICATION SHEET

LINE™ Downlight LED

TYPE:

PROJECT NAME:

L223004

MODEL #

FINISH

LED COLOR

OPTIC

DRIVER

VOLTAGE

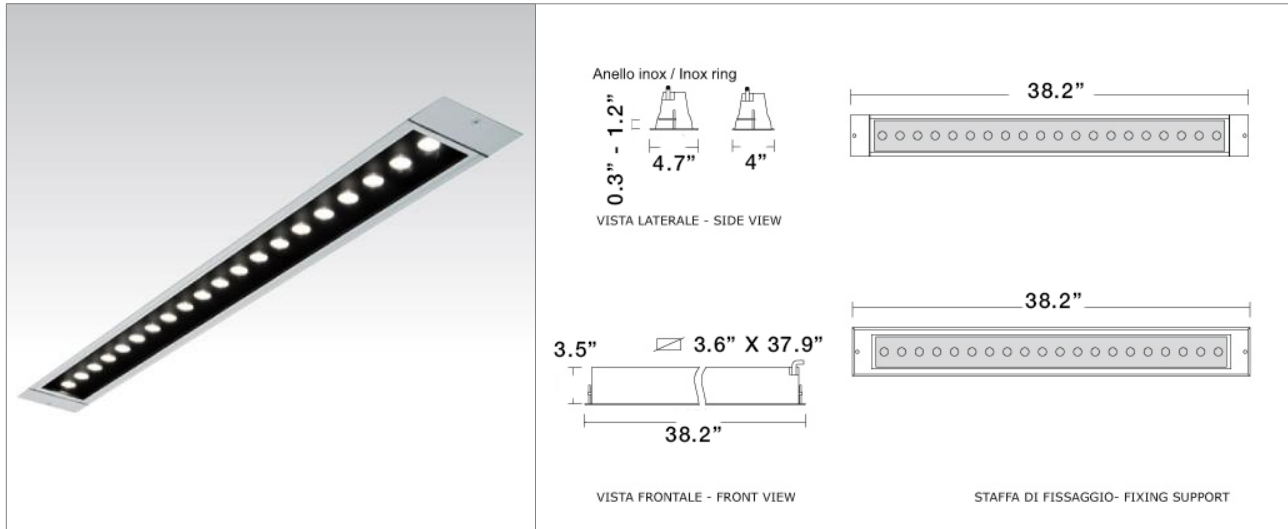

SPECIFICATION SHEET

Housing:

Extruded aluminium body 6060T5, Die-cast aluminium ring with high oxidation resistance ENAB 44300, Aluminium fixing flasks..

Diffuser:

Transparent tempered glass diffuser (on request frosted glass)

Closing screws:

Screws in stainless steel A4

Rubber gasket:

Epdm rubber gaskets

Wiring:

Brass cable blocker IP68 for cable @7-10mm.

Installation:

Downlight.

Weight:

3.20 kg

Finish:

.1 anthracite, .4 grey aluminium

Accessories:

L22104 connector IP68.

LED Driver Voltage Option:

120 - 277V

SOURCE DESCRIPTION

LED Options:

.27 4000°K .28 3000°K. .29 6000°K. .31 beam 10° .32 beam 40° .EL beam elliptical

CRI:

CRI 85

Rated luminous flux:

Lighting flow: 1310 lumen. Total absorbed power 27w.

CERTIFICATIONS

Normative:

EN60598 and relative specifications

Certification:

ETL

Protection Class:

IP67-IK08 (versions with inox ring IK09)

SPECIFICATION SHEET

LINE™ Downlight LED

TYPE:

PROJECT NAME:

L223015

MODEL #

FINISH

LED COLOR

OPTIC

DRIVER

VOLTAGE

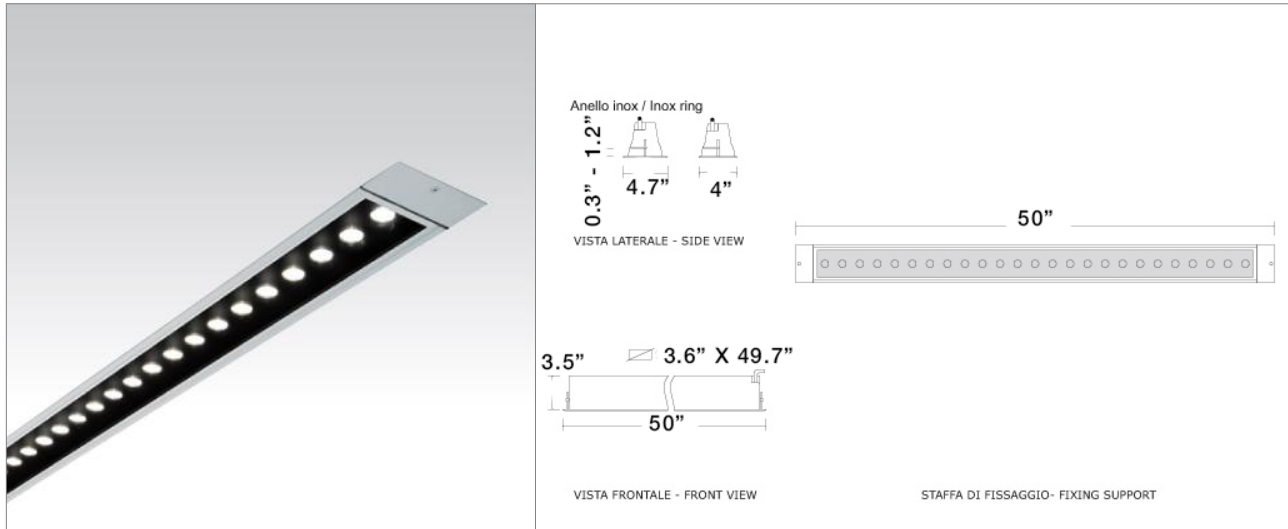

SPECIFICATION SHEET

Housing:

Extruded aluminium body 6060T5, Die-cast aluminium ring with high oxidation resistance ENAB 44300, Aluminium fixing flasks..

Diffuser:

Transparent tempered glass diffuser (on request frosted glass)

Closing screws:

Screws in stainless steel A4

Rubber gasket:

Epdm rubber gaskets

Wiring:

Brass cable blocker IP68 for cable @7-10mm.

Installation:

Downlight.

Weight:

3.20 kg

Finish:

.1 anthracite, .4 grey aluminium

Accessories:

L22104 connector IP68.

LED Driver Voltage Option:

120 - 277V

SOURCE DESCRIPTION

LED Options:

.27 4000°K .28 3000°K. .29 6000°K. .31 beam 10° .32 beam 40° .EL beam elliptical

CRI:

CRI 85

Rated luminous flux:

Lighting flow: 1650 lumen. Total absorbed power 33w.

CERTIFICATIONS

Normative:

EN60598 and relative specifications

Certification:

ETL

Protection Class:

IP67-IK08 (versions with inox ring IK09)

SPECIFICATION SHEET