

# SPOTE™ 2.2

OUTDOOR PROJECTOR SUBMERSIBLE

TYPE:

PROJECT NAME:

## ELECTRICAL FEATURES

POWER CONSUMPTION 4W - 6W

POWER SUPPLY C.C.

POWER SUPPLY UNIT 4W - 350mA  
6W - 500mA

CONNECTION Series

## LIGHTING FEATURES

LED COLOUR 2200K, 2700K, 3000K, 4000K, Red, Green, Blue

CRI >80 (2200K, 2700K, 3000K, 4000K)

OPTICS 8°, 16°, 30°, 40°, 64°

3000K REAL OUTPUT FLUX 4W 326lm 30° - 6W 465lm 30°

AVERAGE LED LIFE 50.000h L80 B10

## MECHANICAL FEATURES

WEIGHT kg 1,15

FINISHES Steel

INSTALLATION Floor, wall or ceiling mounting with bracket (included), in ground with peg (not included), on poles / trees by mounting strap (not included), immersion also with ballast base (not included)

MATERIAL Anticorodal aluminum body or stainless steel AISI 316L body for Sub version, satinized stainless steel bracket, transparent tempered glass

## GENERAL FEATURES

OPERATING TEMPERATURE -10°C +45°C

INGRESS PROTECTION IP68

IMPACT RESISTANCE IK08

GLOW WIRE TEST 960°C

CLASS II

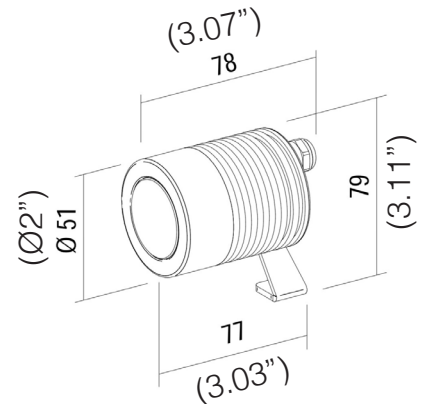
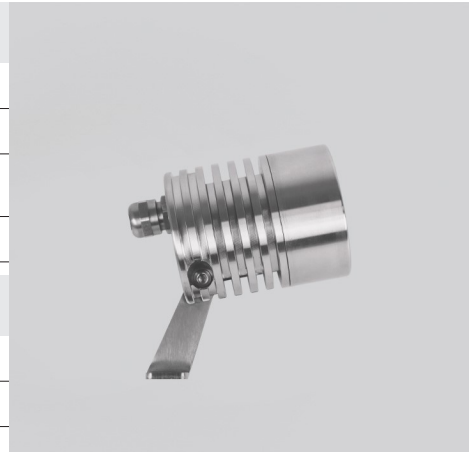

## ORDERING INFO

Model (Order Code)	Optic Options	LED	Accessories	Filter	Dimming Options
<input type="radio"/> SPOTE 2.2 4W	<input type="radio"/> 08: 8°	<input type="radio"/> 22: 2200K	<input type="radio"/> PI002: Peg	<input type="radio"/> HC: Honeycomb Filter	<input type="radio"/> 120V LTE
<input type="radio"/> SPOTE 2.2 6W	<input type="radio"/> 16: 16°	<input type="radio"/> 27: 2700K	<input type="radio"/> BAP01: Base		<input type="radio"/> 120-277V 0-10V
	<input type="radio"/> 30: 30°	<input type="radio"/> 30: 3000K	<input type="radio"/> CIN20: Mounting Strap		
	<input type="radio"/> 40: 40°	<input type="radio"/> 40: 4000K			
	<input type="radio"/> 64: 64°	<input type="radio"/> R: Red			
		<input type="radio"/> G: Green			
		<input type="radio"/> B: Blue			

SPECIFICATION SHEET



LEDOLOGY®

A Luminart® BRAND

WWW.LEDOLOGY.COM

# SPOTE™ 2.2

OUTDOOR PROJECTOR SUBMERSIBLE

TYPE:

PROJECT NAME:

## ACCESSORIES

CODE	PI002
DESCRIPTION	Peg  kg 0,10
MATERIAL	Stainless steel

21,5 (0.84")



CODE	BAP01
DESCRIPTION	Base  kg 0,18
MATERIAL	Stainless steel

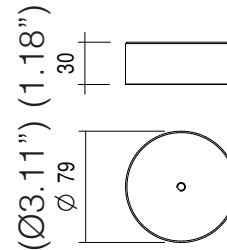

CODE	CIN20
DESCRIPTION	Mounting Strap  kg 0,11
MATERIAL	Polyester tape, stainless steel buckle and base

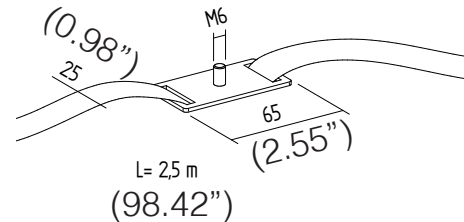

## FILTER

CODE	HC
DESCRIPTION	Honeycomb filter

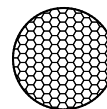

SPECIFICATION SHEET