

BRITE™ MAXI RGB

RECESSED

TYPE:

PROJECT NAME:

LIGHTING FEATURES

LED COLOUR	RGBW
OPTICS	30°, Diffused, 40°, 64°
AVERAGE LED LIFE	50.000h L80 B10

MECHANICAL FEATURES

WEIGHT	Kg 0,31
FINISHES	Anodized aluminum, Steel
INSTALLATION	Recessed in ground with housing box, recessed in plasterboard or wood with springs, recessed in brickwork with housing box
MATERIAL	Anticorodal anodized aluminum body, anodized aluminum or AISI 316L stainless steel trim, transparent tempered glass and PMMA lens

GENERAL FEATURES

OPERATING TEMPERATURE	-10°C +45°C
INGRESS PROTECTION	IP67
IMPACT RESISTANCE	IK08
GLOW WIRE TEST	960°C
CLASS	II

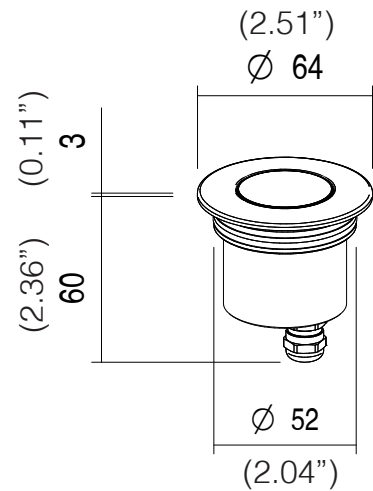
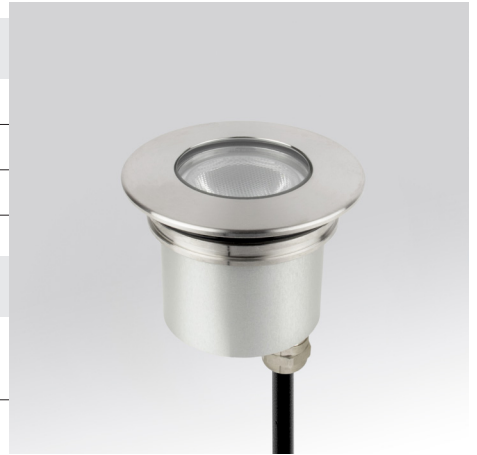

ORDERING INFO

Model (Order Code)	Structure Finish	Optic Options	Accessories	Filter Options	LED	Remote Driver
<input type="radio"/> BRITE MAXI RGB 6W	<input type="radio"/> A: Anodized Aluminum <input type="radio"/> S: AISI 316L Stainless Steel Marine Grade	<input type="radio"/> 30: 30° <input type="radio"/> D: Diffused <input type="radio"/> 40: 40° <input type="radio"/> 60: 60°	<input type="radio"/> ML053: Torsion Spring <input type="radio"/> CAW53: Housing Box <input type="radio"/> CAI53: Housing Box	<input type="radio"/> HC: Honeycombo	<input type="radio"/> RGB	<input type="radio"/> 120V LTE <input type="radio"/> 120-277V 0-10V



SPECIFICATION SHEET

LEDOLOGY®

A **Luminart** BRAND

WWW.LEDOLOGY.COM
Last updated: 08/19/24

BRITE™ MAXI RGB

RECESSED - ACCESSORIE

TYPE:

PROJECT NAME:

CODE	ML053	
TPOLOGY	Torsion spring	 kg 0,001
MATERIAL	Stainless steel	

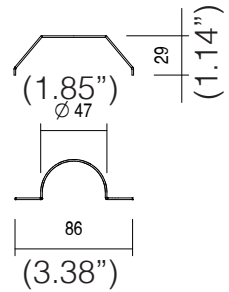

CODE	CAW53	
TPOLOGY	Housing box	 kg 0,09
MATERIAL	PVC	

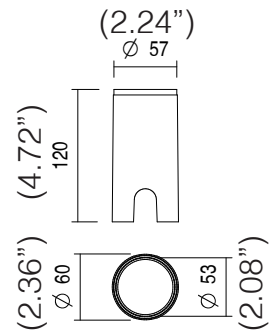

CODE	CAI53	
TPOLOGY	Housing box	 kg 0,06
MATERIAL	ABS	

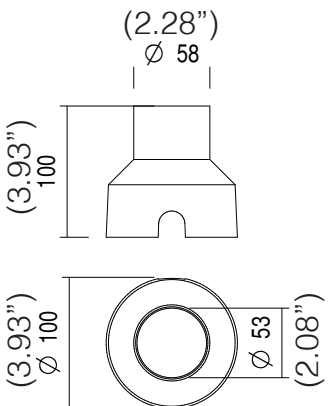

to be chosen

SPECIFICATION SHEET

BRITE™ MAXI RGB

RECESSED - FILTER

TYPE:

PROJECT NAME:

CODE

HC

TPOLOGY

Honeycomb filter

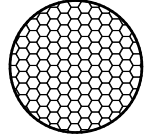

SPECIFICATION SHEET