

LSPX+™ 50

SPOTLIGHT

TYPE:

PROJECT NAME:



Mounting	Ground mounted with adjustable holder and anchor, Pole mounted with luminaire holder for max. 2 Piston on Ø60mm (2.36") tube.
Material	Aluminum body, PMMA optic
LED	2700K, 3000K, 4000K
Dimmer	Remote driver, LTE / 0-10V
Ingress Protection	IP67
CRI	>80
Class	II
Lifetime	100.000h L80B10

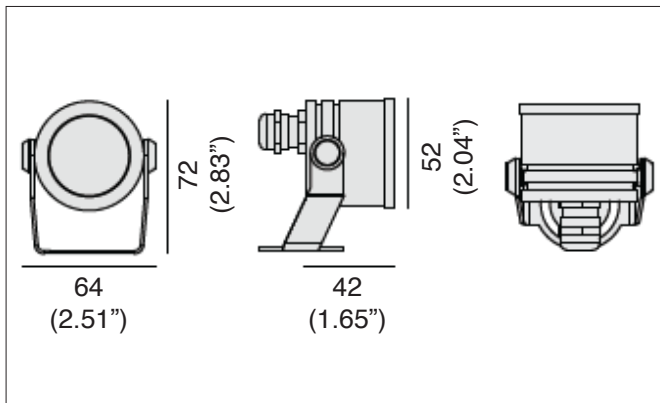

Power [W]	Luminaire Light Flux [lm]		
	2700K	3000K	4000K
1W	120 lm	125 lm	130 lm
2W	240 lm	250 lm	261 lm

- 03 White
- 06 Grey
- 05 Black
- 70 Anthracite

ORDERING INFO

L599095 50LV

Model (Order Code)	Power	Finish Options	Optic Options	LED	Remote Driver Options
<input type="radio"/> L599095 50LV	<input type="radio"/> 1: 1W <input type="radio"/> 2: 2W	<input type="radio"/> 03: White <input type="radio"/> 06: Grey <input type="radio"/> 05: Black <input type="radio"/> 70: Anthracite	<input type="radio"/> 10: 10° <input type="radio"/> 20: 20° <input type="radio"/> 40: 40° <input type="radio"/> 41: 10° x 45°	<input type="radio"/> 27: 2700K <input type="radio"/> 30: 3000K <input type="radio"/> 40: 4000K	<input type="radio"/> LTE: 120V LTE <input type="radio"/> D10: 120-277V 0-10V

SPECIFICATION SHEET



LEDOLOGY®

A **Luminart** BRAND

WWW.LEDOLOGY.COM
Last updated: 09/06/24





LSPX+™ 50

SPOTLIGHT

TYPE:

PROJECT NAME:

ACCESSORIES ORDERING INFO

Model (Order Code)	Quantity	
<input type="radio"/> 124.00: Connector IP68	-	
<input type="radio"/> 90.10: Splitter box connector IP67	-	
<input type="radio"/> 90.35: Anchor 200	-	
<input type="radio"/> 90.39C: luminaire holder for Ø60mm (2.36") pole	-	  (Mount max. 2 Piston luminaires on pole.)

SPECIFICATION SHEET

LSPX+™ 90

SPOTLIGHT

TYPE:

PROJECT NAME:



Mounting	Ground mounted with adjustable holder and anchor or base. Pole mounted with luminaire holder for max. 2 Piston on Ø60mm (2.36"), Ø100mm (3.93") or Ø120mm (4.72") tube. Tree mounted with bracket.
Material	Aluminum body, PMMA optic
LED	2700K, 3000K, 4000K, 6500K, Amber, Red, Green, Blue
Dimmer	Remote driver, LTE / 0-10V
Ingress Protection	IP67
CRI	>80
Class	II
Lifetime	100.000h L80B10

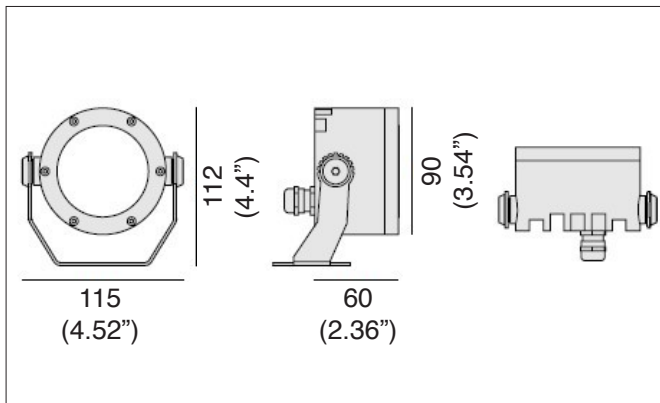

Power [W]	Luminaire Light Flux [lm]		
	2700K	3000K	4000K
3W	382 lm	411 lm	437 lm
6W	764 lm	822 lm	874 lm
9W	955 lm	1026 lm	1092 lm

- 03 White
- 06 Grey
- 05 Black
- 70 Anthracite

ORDERING INFO

L5990211 90LV

Model (Order Code)	Power	Finish Options	Optic Options	LED	Remote Driver Options
<input type="radio"/> L5990211 90LV	<input type="radio"/> 3: 3W <input type="radio"/> 6: 6W <input type="radio"/> 9: 9W	<input type="radio"/> 03: White <input type="radio"/> 06: Grey <input type="radio"/> 05: Black <input type="radio"/> 70: Anthracite	<input type="radio"/> 10: 10° <input type="radio"/> 20: 20° <input type="radio"/> 30: 30° <input type="radio"/> 40: 40° <input type="radio"/> 60: 60° <input type="radio"/> 41: 10° x 45° <input type="radio"/> 8: 8° Wall-washing <input type="radio"/> 45: 45° Wall-washing <input type="radio"/> 02: Asymmetrical	<input type="radio"/> 27: 2700K <input type="radio"/> 30: 3000K <input type="radio"/> 40: 4000K <input type="radio"/> 65: 6500K <input type="radio"/> A: Amber <input type="radio"/> R: Red <input type="radio"/> G: Green <input type="radio"/> B: Blue	<input type="radio"/> LTE: 120V LTE <input type="radio"/> D10: 120-277V 0-10V











SPECIFICATION SHEET

LEDODOGY®

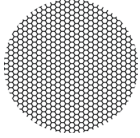
A **Luminart** BRAND

WWW.LEODOGY.COM
Last updated: 09/06/24

ACCESSORIES ORDERING INFO

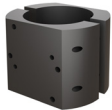
Model (Order Code)	Quantity	
<input type="radio"/> 124.00: Connector IP68	-	
<input type="radio"/> 90.10: Splitter box connector IP67	-	
<input type="radio"/> 90.01: Honeycomb (anti-glare)	-	
<input type="radio"/> 90.02C: Anti-glare cover 360	-	
<input type="radio"/> 90.03C: Anti-glare cover 180	-	
<input type="radio"/> 90.35: Anchor 200	-	
<input type="radio"/> 90.43C: Base/ cover	-	
<input type="radio"/> 90.45C: Bracket	-	  (Mount to tree)
<input type="radio"/> 90.39C: luminaire holder for Ø60mm (2.36") pole <input type="radio"/> 90.51C: luminaire holder for Ø100mm (3.93") pole <input type="radio"/> 90.52C: luminaire holder for Ø1200mm (4.72") pole	-	  (Mount max. 2 Piston luminaires on pole.)

LSPX+™ 140

SPOTLIGHT

TYPE:

PROJECT NAME:



Mounting	Ground mounted with adjustable holder and anchor, base or bracket. Pole mounted with luminaire holder for max. 2 Piston on Ø60mm (2.36"), Ø100mm (3.93") or Ø120mm (4.72") tube. Tree mounted with bracket.
Material	Aluminum body, PMMA optic
LED	2700K, 3000K, 4000K, 6500K, Amber, Red, Green, Blue
Dimmer	Remote driver, LTE / 0-10V
Ingress Protection	IP67
CRI	>80
Class	II
Lifetime	100.000h L80B10

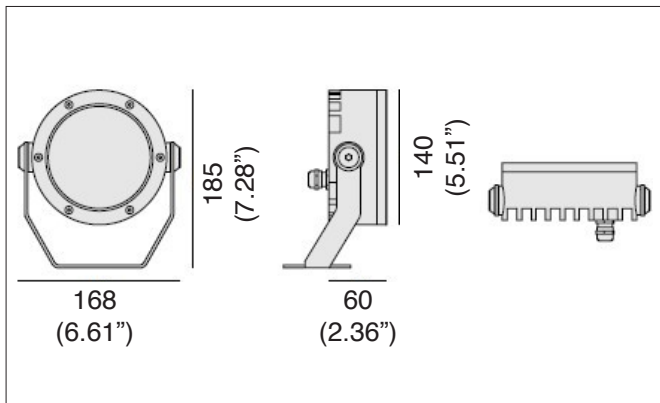

Power [W]	Luminaire Light Flux [lm]		
	2700K	3000K	4000K
8W	1019 lm	1095 lm	1165 lm
16W	2037 lm	2191 lm	2331 lm
24W	2546 lm	2737 lm	2912 lm



SPECIFICATION SHEET

ORDERING INFO

L5990211 140LV

Model (Order Code)	Power	Finish Options	Optic Options	LED	Remote Driver Options
<input type="radio"/> L5990211 140LV	<input type="radio"/> 8: 8W <input type="radio"/> 16: 16W <input type="radio"/> 24: 24W	<input type="radio"/> 03: White <input type="radio"/> 06: Grey <input type="radio"/> 05: Black <input type="radio"/> 70: Anthracite	<input type="radio"/> 10: 10° <input type="radio"/> 20: 20° <input type="radio"/> 30: 30° <input type="radio"/> 40: 40° <input type="radio"/> 60: 60° <input type="radio"/> 41: 10° x 45° <input type="radio"/> 8: 8° Wall-washing <input type="radio"/> 45: 45° Wall-washing <input type="radio"/> 02: Asymmetrical	<input type="radio"/> 27: 2700K <input type="radio"/> 30: 3000K <input type="radio"/> 40: 4000K <input type="radio"/> 65: 6500K <input type="radio"/> A: Amber <input type="radio"/> R: Red <input type="radio"/> G: Green <input type="radio"/> B: Blue	<input type="radio"/> LTE: 120V LTE <input type="radio"/> D10: 120-277V 0-10V



LEDOLOGY®

A **Luminart** BRAND

WWW.LEDOLOGY.COM
Last updated: 09/06/24









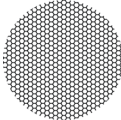

LSPX+™ 140

SPOTLIGHT

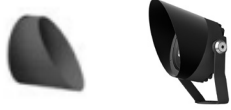
TYPE:

PROJECT NAME:

ACCESSORIES ORDERING INFO

Model (Order Code)	Quantity	
<input type="radio"/> 124.00: Connector IP68	-	
<input type="radio"/> 90.10: Splitter box connector IP67	-	
<input type="radio"/> 90.04: Honeycomb (anti-glare)	-	
<input type="radio"/> 90.05C: Anti-glare cover 360	-	
<input type="radio"/> 90.06C: Anti-glare cover 180	-	
<input type="radio"/> 90.36: Anchor 300	-	
<input type="radio"/> 90.44C: Base/ cover	-	
<input type="radio"/> 90.46C: Bracket	-	  (Mount to tree)
<input type="radio"/> 90.39C: luminaire holder for Ø60mm (2.36") pole <input type="radio"/> 90.51C: luminaire holder for Ø100mm (3.93") pole <input type="radio"/> 90.52C: luminaire holder for Ø1200mm (4.72") pole	-	  (Mount max. 2 Piston luminaires on pole.)
<input type="radio"/> 90.42C: Bracket	-	 (Mount to ground)

SPECIFICATION SHEET

LSPX+™ 200

SPOTLIGHT

TYPE:

PROJECT NAME:



Mounting	Ground mounted with adjustable holder and anchor, base or bracket. Pole mounted with luminaire holder for max. 2 Piston on Ø60mm (2.36"), Ø100mm (3.93") or Ø120mm (4.72") tube. Tree mounted with bracket.
Material	Aluminum body, PMMA optic
LED	2700K, 3000K, 4000K, 6500K, Amber, Red, Green, Blue
Dimmer	Remote driver, LTE / 0-10V
Ingress Protection	IP67
CRI	>80
Class	II
Lifetime	100.000h L80B10

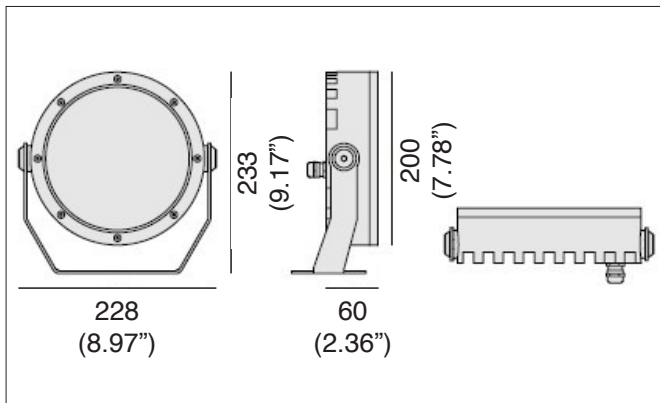

Power [W]	Luminaire Light Flux [lm]		
	2700K	3000K	4000K
22W	2802 lm	3012 lm	3205 lm
44W	5603 lm	6025 lm	6409 lm
66W	7001 lm	7528 lm	8008 lm

- 03 White
- 06 Grey
- 05 Black
- 70 Anthracite

ORDERING INFO

L5990211 200LV

Model (Order Code)	Power	Finish Options	Optic Options	LED	Remote Driver Options
<input type="radio"/> L5990211 200LV	<input type="radio"/> 22: 22W <input type="radio"/> 44: 44W <input type="radio"/> 66: 66W	<input type="radio"/> 03: White <input type="radio"/> 06: Grey <input type="radio"/> 05: Black <input type="radio"/> 70: Anthracite	<input type="radio"/> 10: 10° <input type="radio"/> 20: 20° <input type="radio"/> 30: 30° <input type="radio"/> 40: 40° <input type="radio"/> 60: 60° <input type="radio"/> 41: 10° x 45° <input type="radio"/> 8: 8° Wall-washing <input type="radio"/> 45: 45° Wall-washing <input type="radio"/> 02: Asymmetrical	<input type="radio"/> 27: 2700K <input type="radio"/> 30: 3000K <input type="radio"/> 40: 4000K <input type="radio"/> 65: 6500K <input type="radio"/> A: Amber <input type="radio"/> R: Red <input type="radio"/> G: Green <input type="radio"/> B: Blue	<input type="radio"/> LTE: 120V LTE <input type="radio"/> D10: 120-277V 0-10V



SPECIFICATION SHEET

LEDOLOGY®

A **Luminart** BRAND

WWW.LEDOLOGY.COM
Last updated: 09/06/24









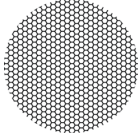

LSPX+™ 200

SPOTLIGHT

TYPE:

PROJECT NAME:

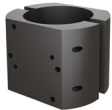
ACCESSORIES ORDERING INFO

Model (Order Code)	Quantity	
<input type="radio"/> 124.00: Connector IP68	-	
<input type="radio"/> 90.10: Splitter box connector IP67	-	
<input type="radio"/> 90.07: Honeycomb (anti-glare)	-	
<input type="radio"/> 90.08C: Anti-glare cover 360	-	
<input type="radio"/> 90.09C: Anti-glare cover 180	-	
<input type="radio"/> 90.35: Anchor 300	-	
<input type="radio"/> 90.53C: Base/ cover	-	
<input type="radio"/> 90.47C: Bracket	-	  (Mount to tree)
<input type="radio"/> 90.39C: luminaire holder for Ø60mm (2.36") pole <input type="radio"/> 90.51C: luminaire holder for Ø100mm (3.93") pole <input type="radio"/> 90.52C: luminaire holder for Ø1200mm (4.72") pole	-	  (Mount max. 2 Piston luminaires on pole.)

SPECIFICATION SHEET