

LSPX™ 90

SPOTLIGHT

TYPE:

PROJECT NAME:



| | |
|--------------------|--|
| Mounting | Ground mounted with adjustable holder and anchor or base. Pole mounted with luminaire holder for max. 2 Piston on Ø60mm (2.36"), Ø100mm (3.93") or Ø120mm (4.72") tube. Tree mounted with bracket. |
| Material | Aluminum body, PMMA optic |
| LED | 2700K, 3000K, 4000K, 6500K, Amber, Red, Green, Blue |
| Dimmer | Remote driver, LTE / 0-10V |
| Ingress Protection | IP67 |
| CRI | >80 |
| Class | II |
| Lifetime | 100.000h L80B10 |

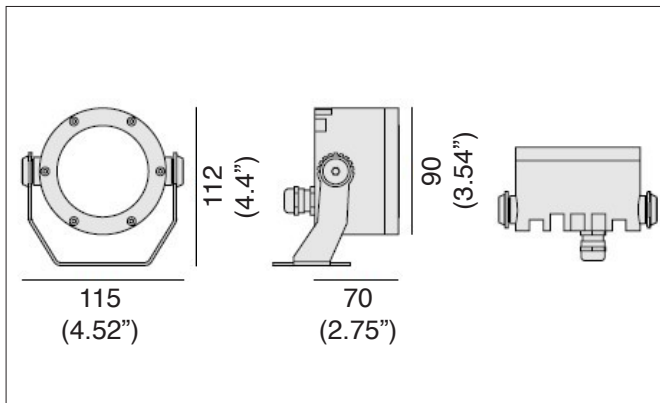

| Power [W] | Luminaire Light Flux [lm] | | |
|-----------|---------------------------|--------|--------|
| | 2700K | 3000K | 4000K |
| 1W | 137 lm | 142 lm | 149 lm |
| 2W | 274 lm | 285 lm | 297 lm |
| 3W | 369 lm | 384 lm | 401 lm |

- 03 White
- 06 Grey
- 05 Black
- 70 Anthracite

ORDERING INFO

L599372 90LV

| Model (Order Code) | Power | Finish Options | LED | Remote Driver Options |
|------------------------------------|---|--|---|--|
| <input type="radio"/> L599372 90LV | <input type="radio"/> 1: 1W <input type="radio"/> 2: 2W <input type="radio"/> 3: 3W | <input type="radio"/> 03: White <input type="radio"/> 06: Grey <input type="radio"/> 05: Black <input type="radio"/> 70: Anthracite | <input type="radio"/> 27: 2700K <input type="radio"/> 30: 3000K <input type="radio"/> 40: 4000K <input type="radio"/> 65: 6500K <input type="radio"/> A: Amber <input type="radio"/> R: Red <input type="radio"/> G: Green <input type="radio"/> B: Blue | <input type="radio"/> LTE: 120V LTE <input type="radio"/> D10: 120-277V 0-10V |



SPECIFICATION SHEET

LEDODOLOGY®

A **Luminart** BRAND

WWW.LEDOLOGY.COM
Last updated: 09/06/24





LSPX™ 90

SPOTLIGHT

TYPE:

PROJECT NAME:

ACCESSORIES ORDERING INFO

| Model (Order Code) | Quantity | |
|--|----------|--|
| <input type="radio"/> 124.00: Connector IP68 | - |  |
| <input type="radio"/> 90.02C: Anti-glare cover 360 | - |  |
| <input type="radio"/> 90.03C: Anti-glare cover 180 | - |  |
| <input type="radio"/> 90.35: Anchor 200 | - |  |
| <input type="radio"/> 90.43C: Base/ cover | - |  |
| <input type="radio"/> 90.45C: Bracket | - |   (Mount to tree) |
| <input type="radio"/> 90.39C: luminaire holder for Ø60mm (2.36") pole <input type="radio"/> 90.51C: luminaire holder for Ø100mm (3.93") pole <input type="radio"/> 90.52C: luminaire holder for Ø1200mm (4.72") pole | - |   (Mount max. 2 Piston luminaires on pole.) |

SPECIFICATION SHEET

LSPX™ 140

SPOTLIGHT

TYPE:

PROJECT NAME:



| | |
|--------------------|--|
| Mounting | Ground mounted with adjustable holder and anchor or base. Pole mounted with luminaire holder for max. 2 Piston on Ø60mm (2.36"), Ø100mm (3.93") or Ø120mm (4.72") tube. Tree mounted with bracket. |
| Material | Aluminum body, PMMA optic |
| LED | RGB |
| Dimmer | Remote driver, LTE / 0-10V |
| Ingress Protection | IP67 |
| CRI | >80 |
| Class | II |
| Lifetime | 100.000h L80B10 |

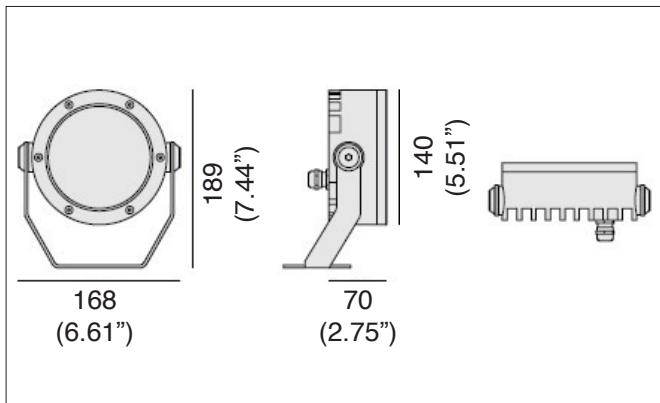

| Power [W] | Luminaire Light Flux [lm] | | |
|-----------|---------------------------|---------|---------|
| | 2700K | 3000K | 4000K |
| 4W | 548 lm | 571 lm | 594 lm |
| 8W | 1094 lm | 1140 lm | 1188 lm |
| 12W | 1479 lm | 1540 lm | 1604 lm |

- 03 White
- 06 Grey
- 05 Black
- 70 Anthracite

ORDERING INFO

L599377 140LV

| Model (Order Code) | Power | Finish Options | LED | Remote Driver Options |
|-------------------------------------|---|--|---|--|
| <input type="radio"/> L599377 140LV | <input type="radio"/> 4: 4W <input type="radio"/> 8: 8W <input type="radio"/> 12: 12W | <input type="radio"/> 03: White <input type="radio"/> 06: Grey <input type="radio"/> 05: Black <input type="radio"/> 70: Anthracite | <input type="radio"/> 27: 2700K <input type="radio"/> 30: 3000K <input type="radio"/> 40: 4000K <input type="radio"/> 65: 6500K <input type="radio"/> A: Amber <input type="radio"/> R: Red <input type="radio"/> G: Green <input type="radio"/> B: Blue | <input type="radio"/> LTE: 120V LTE <input type="radio"/> D10: 120-277V 0-10V |



SPECIFICATION SHEET

LEDOLOGY®

A **Luminart** BRAND

WWW.LEDOLOGY.COM
Last updated: 09/06/24









LSPX™ 140

SPOTLIGHT

TYPE:

PROJECT NAME:

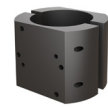
ACCESSORIES ORDERING INFO

| Model (Order Code) | Quantity | |
|--|----------|--|
| <input type="radio"/> 124.00: Connector IP68 | - |  |
| <input type="radio"/> 90.02C: Anti-glare cover 360 | - |  |
| <input type="radio"/> 90.03C: Anti-glare cover 180 | - |  |
| <input type="radio"/> 90.36: Anchor 300 | - |  |
| <input type="radio"/> 90.44C: Base/ cover | - |  |
| <input type="radio"/> 90.46C: Bracket | - |   (Mount to tree) |
| <input type="radio"/> 90.39C: luminaire holder for Ø60mm (2.36") pole <input type="radio"/> 90.51C: luminaire holder for Ø100mm (3.93") pole <input type="radio"/> 90.52C: luminaire holder for Ø1200mm (4.72") pole | - |   (Mount max. 2 Piston luminaires on pole.) |
| <input type="radio"/> 90.42C: Bracket | - |  (Mount to ground) |

SPECIFICATION SHEET