

# ACOUST™ WALL

ACOUSTIC WALL SYSTEM

TYPE:

PROJECT NAME:

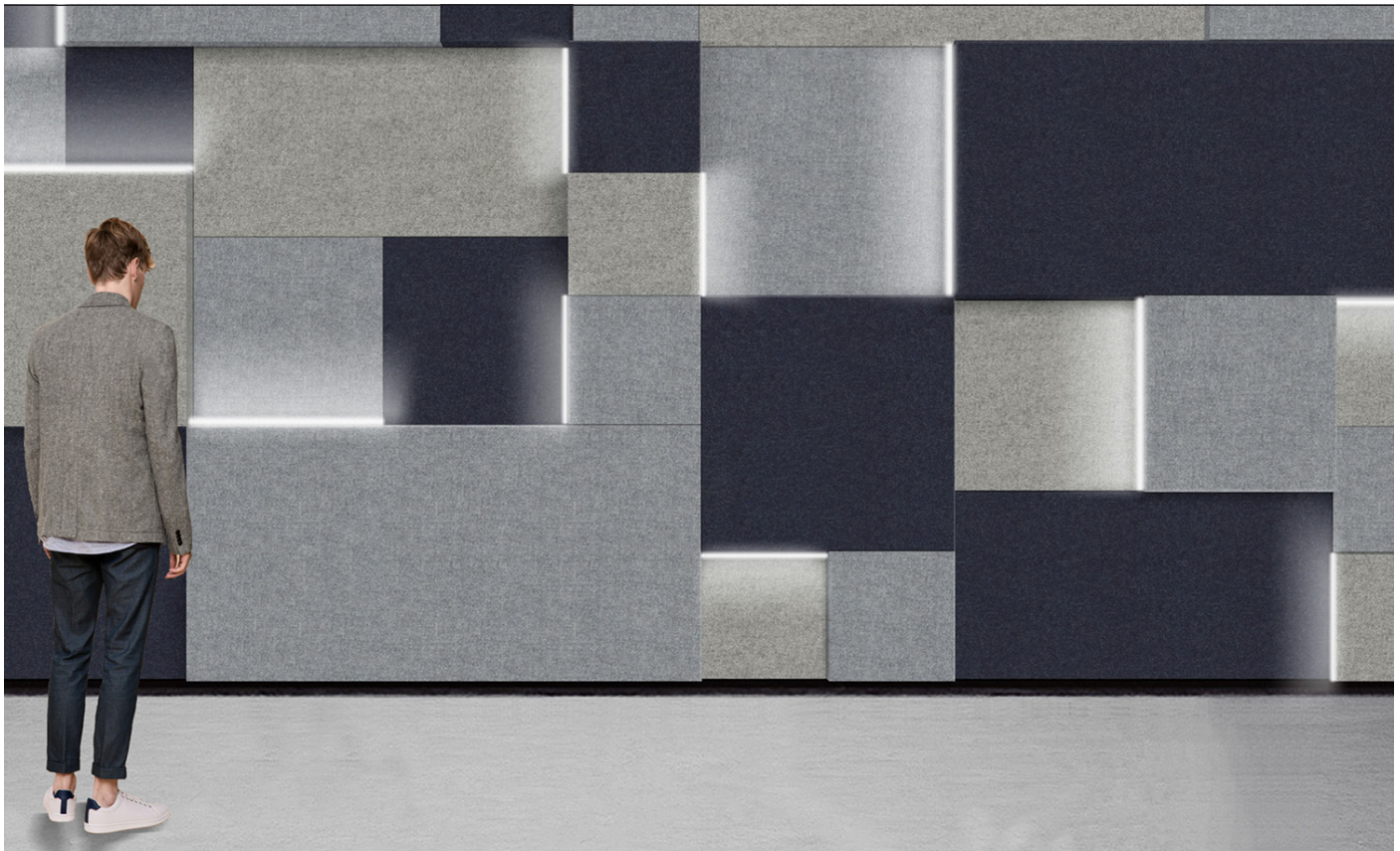

**Luminaire characteristics:** Luminaire only  
**Input load:** 4.6W/ft. (LED only)  
**Lumens:** 150 to 175 lm/ft. (delivered 3000K)  
**Luminaire efficacy:** 23 to 27 lm/W (3000k)

**Source:** LED module  
 2700K, 3000K or 3500K  
**Lumen maintenance:** 70% of initial lumens at 50 000 hours

**Optics:**  
**Wide flood:** 82° with white diffuser.

**Mounting:** Full length mounting slot for adjustable mounting system. Mounting screws and support system included. 3ft long power cable included.

**Material:**  
 Body: Aluminum extrusion  
 End caps:

**Electrical:** See page 2.

**Dimming:** See page 2.

**Finish:** gray

**Warranty:** 5 year limited warranty.

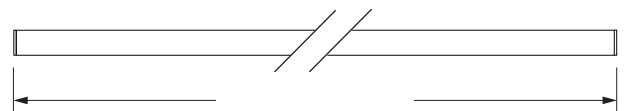
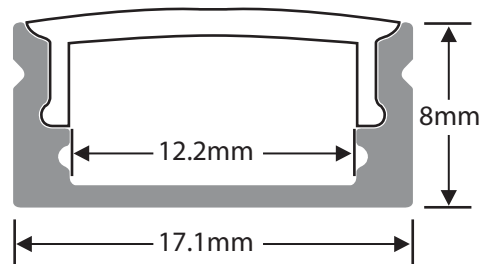

FRONT VIEW

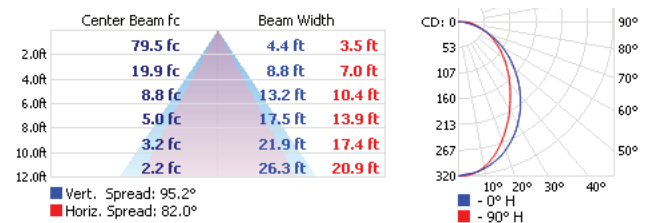

SPECIFICATION SHEET

LEDODOLOGY®

A **Luminart** BRAND

WWW.LEDODOLOGY.COM  
 Last updated: 03/03/21

# ACOUST™ WALL

ACOUSTIC WALL SYSTEM

TYPE:

PROJECT NAME:

## ORDERING INFO - FOR LED STRIPS

L7050AP	-	-	-	-	-	-	↓
Model	LED	Optic	Mounting	Driver	Voltage/Dim	Length Options <i>Matched to lengths of acoustic panels</i>	Quantities Desired <i>Enter the quantity of each length desired</i>
	<input type="radio"/> 2700K <input type="radio"/> 3000K <input type="radio"/> 3500K	<input type="radio"/> WLF White Lens Flood <input type="radio"/> CL Clear Lens	<input type="radio"/> 90° <input type="radio"/> Wall <input type="radio"/> Recessed	<input type="radio"/> 30W 24V <input type="radio"/> 60W 24V <input type="radio"/> 96W 24V	<input type="radio"/> 120V LTE Dim <input type="radio"/> 120V 0-10V Dim <input type="radio"/> 277V 0-10V Dim	60cm (23.6") 80cm (31.5") 100cm (39.4") 120cm (47.2") 160cm (63") 180cm (70.9") 200cm (78.7")	_____ _____ _____ _____ _____ _____



## Acoustical Panel Options

### Squares

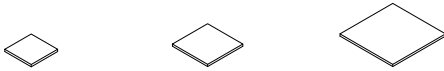

MODEL	LP5-S-60.60	LP5-S-80.80	LP5-S-120.120
CM	60x60x5	80x80x5	120x120x5
INCHES	23.6x23.6x2	31.5x31.5x2	47.2x47.2x2

### Rectangles

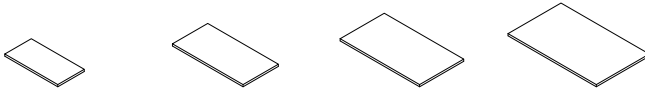

MODEL	LP5-R-120.60	LP5-R-160.80	LP5-R-180.100	LP5-R-200.120
CM	120x60x5	160x80x5	180x100x5	200x120x5
INCHES	47.2x23.6x2	63x31.5x2	70.9x39.4x2	78.7x47.2x2

### Standard seam

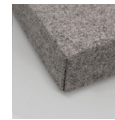

### Other seam options

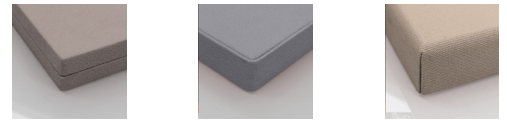

### Two-colored panel available on request

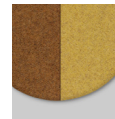

## ORDERING INFO - FOR ACOUSTIC PANELS

Panel Model      -      Fabric Finish (see page 3-6)      -      Quantities Desired

_____	_____	_____
_____	_____	_____
_____	_____	_____
_____	_____	_____
_____	_____	_____
_____	_____	_____
_____	_____	_____
_____	_____	_____
_____	_____	_____
_____	_____	_____

SPECIFICATION SHEET



# ACOUSTIC™ WALL

ACOUSTIC WALL SYSTEM

TYPE:

PROJECT NAME:

## Fabric Options: "Trevira CS" Palette (100% Polyester)



Apple green 463



Yellow 53



Light blue 386



Turquoise 366



Beige 532



White 999



Green tea 425



Carrot 66



Capri 379



Iceberg 377



Camel 533



Light grey 611T



Grass 464



Orange 120



Pastel blue 380



Queen blue 378



Tuscan brown 534



Pearl grey 643



Olive 426



Red 231



Steel blue 263



Sapphire 331



Tiger eye 119



Grey 629



Office green 443



Brick 572



Lavender 175



Office blue 332T



Brown sugar 569



Quartz grey 636



Forest green 496



Bordeaux 236



Red wine 234



Dark blue 334T



Taupe 607



Old silver 625



Peacock blue 411



Fuchsia 173



Purple 262



Midnight blue 333T



Dark mud 571



Black 651

SPECIFICATION SHEET

LEDOLOGY®

A Luminart BRAND

WWW.LEDOLOGY.COM  
Last updated: 03/03/21

# ACOUSTIC™ WALL

ACOUSTIC WALL SYSTEM

TYPE:

PROJECT NAME:

## Fabric Options: "ECOfelt" Palette (90% Wool, 10% Polyester)



Beige 952



Yellow 34



Quartz rose 940



Acid green 611E



Fresh air 976



Ghost white 955



Caramel 332E



Mustard 54



Salmon 317



Cashmere green 89



Salvia green 334E



Chalk 327



Mushroom 325



Cob orange 997



Blossom pink 335



Leaf green 910



Light blue 914



Grey 953



Chocolate 352



Orange 971



Pink 988



Avio 333E



Sky blue 942



Mineral blue 311



Taupe 511



Red 5



Violet 921



Lagoon 608



Blue yonder 200



Moonstone 512



Brown 605



Marsala 973



Purple 508



Peacock blue 962



Honolulu blue 607



Ink 329



Dark musk 22



Bordeaux 192



Grape 603



Blue 193



Deep sea blue 963



Dark grey 923

SPECIFICATION SHEET

LEDODOLOGY®

A **Luminart** BRAND

WWW.LEDODOLOGY.COM  
Last updated: 03/03/21

# ACOUSTIC™ WALL

ACOUSTIC WALL SYSTEM

TYPE:

PROJECT NAME:

## Fabric Options: "PETfelt" Palette (100% PET (polyethylene terephthalate))



Grey 4



Yellow 3



Pink 17



Kiwy 28



Light blue 8



Beige 16



Orange 9



Opal 33



Acid green 7



Blue 13



Alabaster 32



Dark Orange 14



Fuchsia 10



Water green 2



Azure 1



Tuscan brown 20



Red 6



Purple 11



La salle green 12



Dark blue 5



Mud 19



Bordeaux 15



Grapes 23

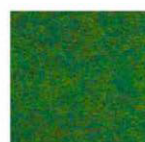

Jungle green 31



Summer night 21



Rich black 18



Sangria 30



Pastel pink 37



Grey green 22

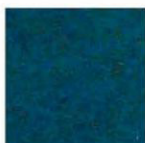

Pacific blue 29



Pale yellow 41



Ruby red 27

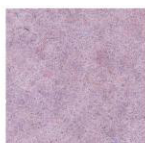

Wisteria pink 36



Celadon 39



Egg blue 38

SPECIFICATION SHEET

LEDOLOGY®

A **Luminart** BRAND

WWW.LEDOLOGY.COM  
Last updated: 03/03/21

# ACOUSTIC™ WALL

ACOUSTIC WALL SYSTEM

TYPE:

PROJECT NAME:

## Fabric Options: "Tweed" Palette (75% Wool, 25% Polyamide)



SPECIFICATION SHEET

LEDOLOGY®

A **Luminart** BRAND

WWW.LEDOLOGY.COM  
Last updated: 03/03/21

# ACOUSTIC™ WALL

ACOUSTIC WALL SYSTEM

TYPE:

PROJECT NAME:

## Installation Instructions

Please note, all configurations are custom - there is no standard layout. The quantity of panels and their arrangement is up to the design that the designer has chosen and submitted to our production team. The following illustrations show how to install the acoustic panels using velcro. Adhesive velcro is included with the Acous Wall acoustic panels.

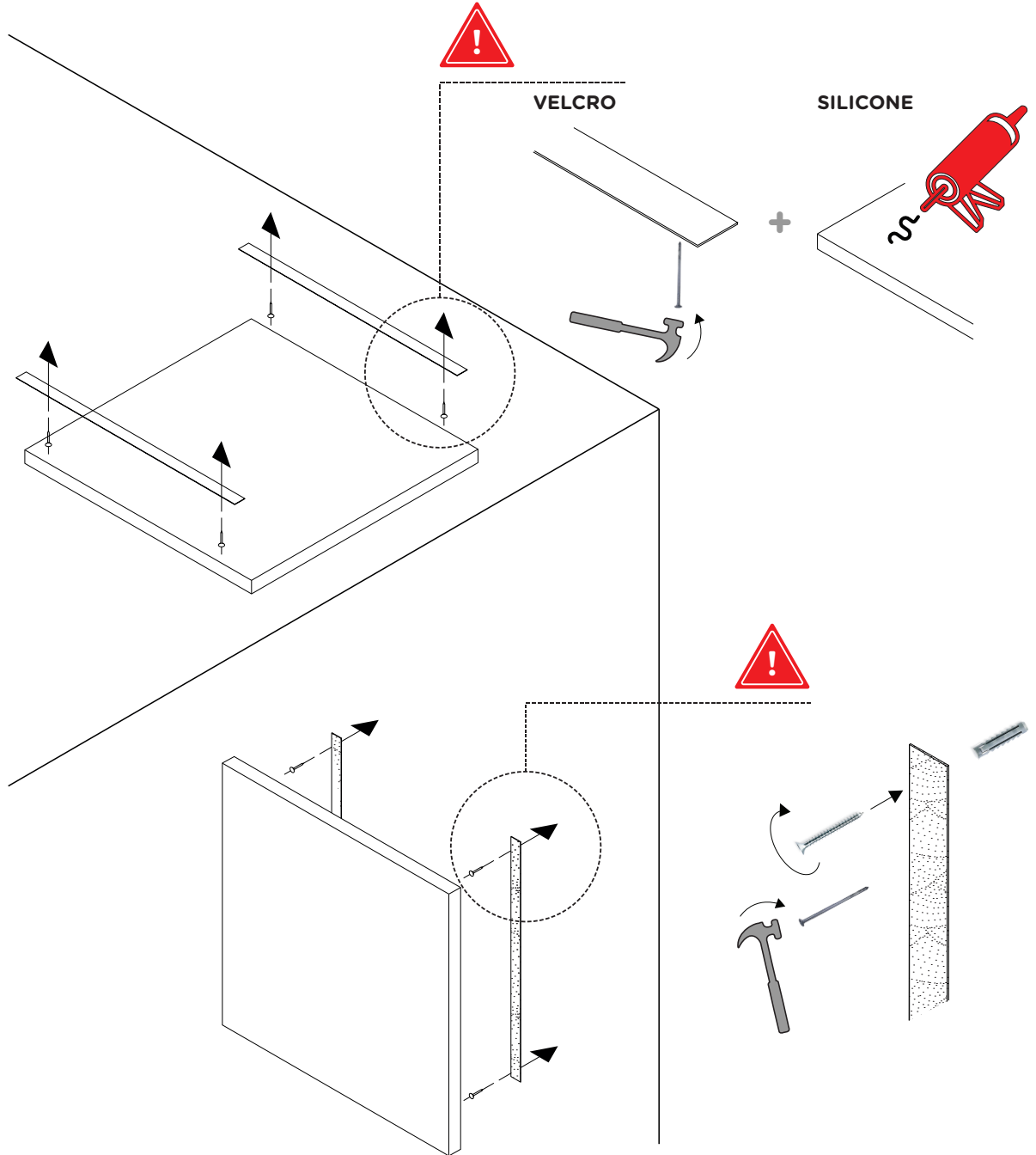
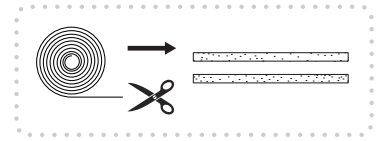

SPECIFICATION SHEET

LEDOLOGY®

A **Luminart** BRAND

WWW.LEDOLOGY.COM  
Last updated: 03/03/21