

IDEA™

CEILING/WALL

TYPE:

PROJECT NAME:

Finish

Frame color:



White



Graphite

Fabric diffusers:



Lycra

Metal structure,
removable lycra
fabric disks

Direct light

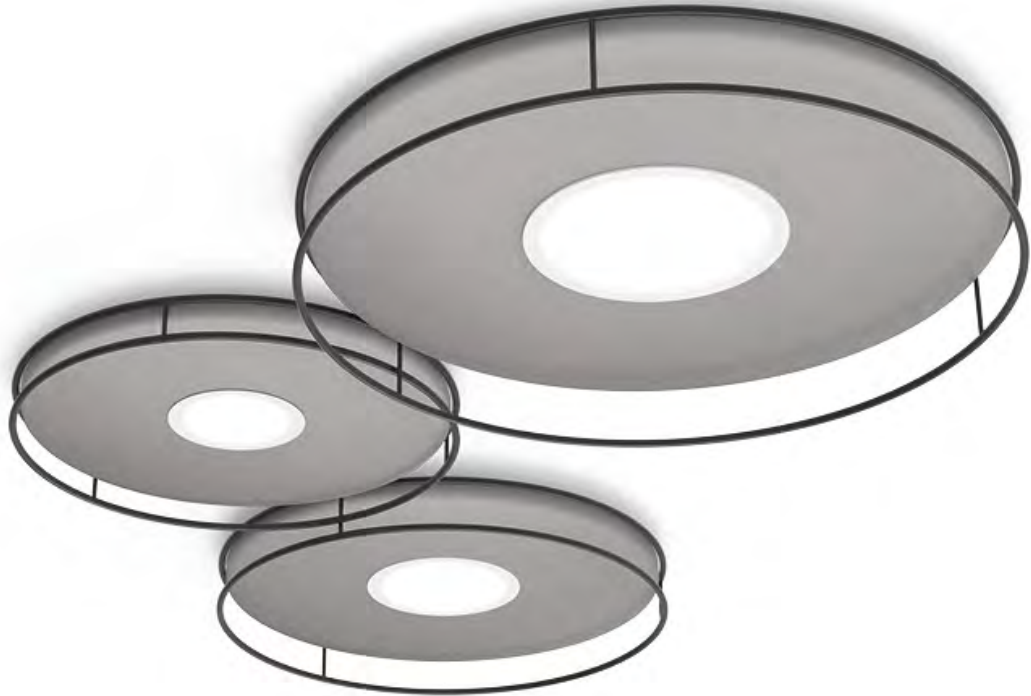

IP20



Anti-Glare
accessory detail



Wall lamp version



SPECIFICATION SHEET



Lycra



Cod. 250
White



Cod. 263
Sand



Cod. 264
Yellow



Cod. 252
Grey



Cod. 262
Gunmetal grey

LEDODOLOGY®

A **Luminart** BRAND

WWW.LEDOLOGY.COM
Last updated: 4/12/21

IDEA™

CEILING/WALL

TYPE:

PROJECT NAME:

Wall/ceiling lamp Ø 66	Ø 66 x 13 cm 10 Kg	lamp type 1 led module 18W luminous efficacy 1660 Lm light colour 2800K 0-10V DIM cri >80	L82IDEEPL060L01
Wall/ceiling lamp Ø 80	Ø 80 x 13 cm 15 Kg	lamp type 1 led module 24W luminous efficacy 2150 Lm light colour 2800K 0-10V DIM cri >85	L82IDEEPL080L01
Wall/ceiling lamp Ø 100	Ø 100 x 13 cm 18 Kg	lamp type 1 led module 24W luminous efficacy 2150 Lm light colour 2800K 0-10V DIM cri >85	L82IDEEPL100L01
Wall/ceiling lamp Ø 140	Ø 140 x 10 cm 25 Kg	lamp type 1 led module 30W luminous efficacy 2400 Lm light colour 2800K 0-10V DIM cri >80	L82IDEEPL140L01

ORDERING INFO

Model (Order Code)	Finish	LED	Voltage	Dimming
		<input type="radio"/> 2800K <input type="radio"/> 3000K <input type="radio"/> 4000K	<input type="radio"/> 120V <input type="radio"/> 277V	<input type="radio"/> LTE (Leading/Trailing Edge Dim) <input type="radio"/> 010V (0-10V)

 Fixture comes with a 4" backplate that mounts to a standard junction box. Please note: 277V is only compatible with 0-10V dimming.

SPECIFICATION SHEET

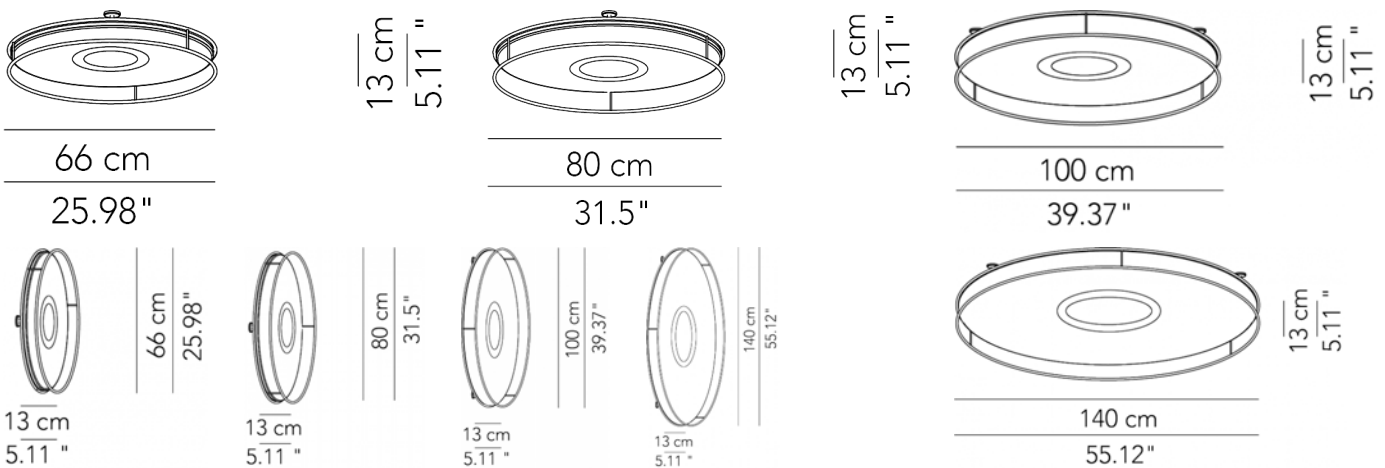

LEDOLOGY®

A **Luminart** BRAND

WWW.LEDOLOGY.COM
Last updated: 4/12/21

TYPE:

PROJECT NAME:

Wall/ceiling lamp - Composition L.100 \varnothing 100 x 58 x 13 cm 3 led modules 3W+ 6W+ 9W L82IDEEDD100L03
 15 Kg luminous efficacy 1480 Lm
 light colour 2800K
 0-10V DIM
 cri >85

Wall/ceiling lamp - Composition L.180 \varnothing 180 x 105 x 13 cm 3 led modules 12W+ 18W+ 24W L82IDEEDD180L03
 30 Kg luminous efficacy 4920 Lm
 light colour 2800K
 0-10V DIM
 cri >85

ORDERING INFO

Model (Order Code)	Finish	LED	Voltage	Dimming
		<input type="radio"/> 2800K	<input type="radio"/> 120V	<input type="radio"/> LTE (Leading/Trailing Edge Dim)
		<input type="radio"/> 3000K	<input type="radio"/> 277V	<input type="radio"/> 010V (0-10V)
		<input type="radio"/> 4000K		

 Fixture comes with a 4" backplate that mounts to a standard junction box. Please note: 277V is only compatible with 0-10V dimming.

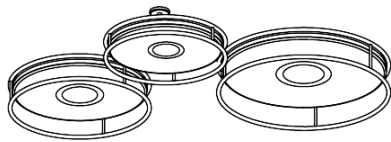

13 cm
5.11"

100 cm

39.37"

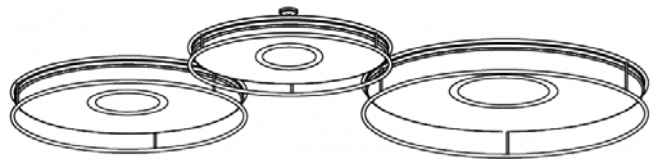

13 cm
5.11"

178 cm

70.08"

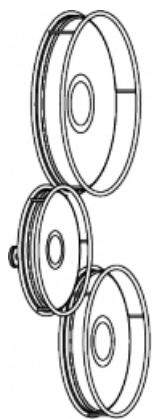

100 cm
39.37"

13 cm
5.11"

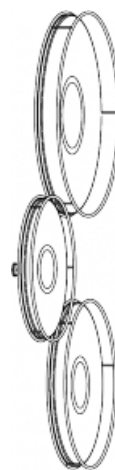

178 cm
70.08"

13 cm
5.11"

SPECIFICATION SHEET