

# SKYLINE™ THIN

RECESSED

TYPE:

PROJECT NAME:



SPECIFICATION SHEET

**LEDOLOGY**®

A **Luminart** BRAND

WWW.LEDOLOGY.COM  
Last updated: 4/12/21

# SKYLINE™ THIN

RECESSED

TYPE:

PROJECT NAME:



**L676615**

0,5 kg

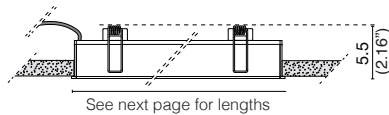

.01

101.5X2.2 cm.  
(39.96"X0.86")



SPECIFICATION SHEET

## ORDERING INFO

Model	Length	Wattage	LED	Dimming	Voltage	Configuration Notes
○ L676615	○ 02: 2'	○ 5W/FT	○ 27K (2700K)	○ LTE (Leading/ Trailing Edge Dim)	○ 120V	
	○ 04: 4'					
	○ 06: 6'	○ 30K (3000K)				
	○ 08: 8'	○ 40K (4000K)				
	○ Custom		○ 010V (0-10V)			

**LEDOLOGY®**

A **Luminart** BRAND





WWW.LEDOLOGY.COM  
Last updated: 4/12/21

# SKYLINE™ THIN

RECESSED

TYPE:

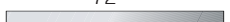
PROJECT NAME:

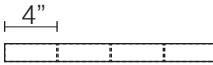
Length	
Standard Lengths	Custom Lengths
<p>2', 4', 6', and 8' precut lengths available. These pieces can be joined together to form longer runs.</p> <p>24" 2' </p> <p>48" 4' </p> <p>72" 6' </p> <p>96" 8' </p>	<p>Custom lengths are available in increments of 4", up to 8'. These can be combined with standard lengths to create, for example, a run that is 4'8". Please remember to add 0.3cm (0.11") x2 for the end caps.</p> <p>4" </p>

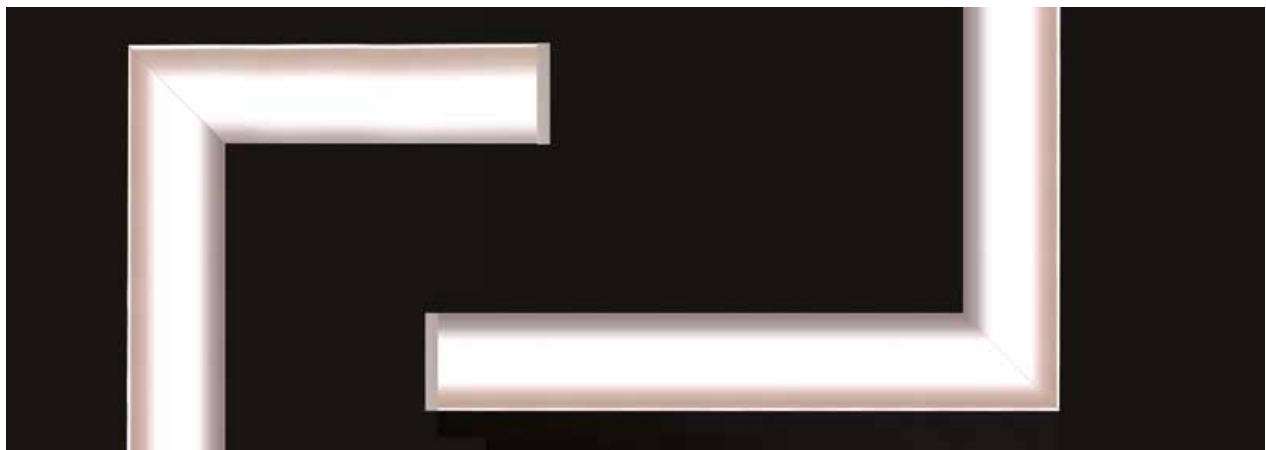
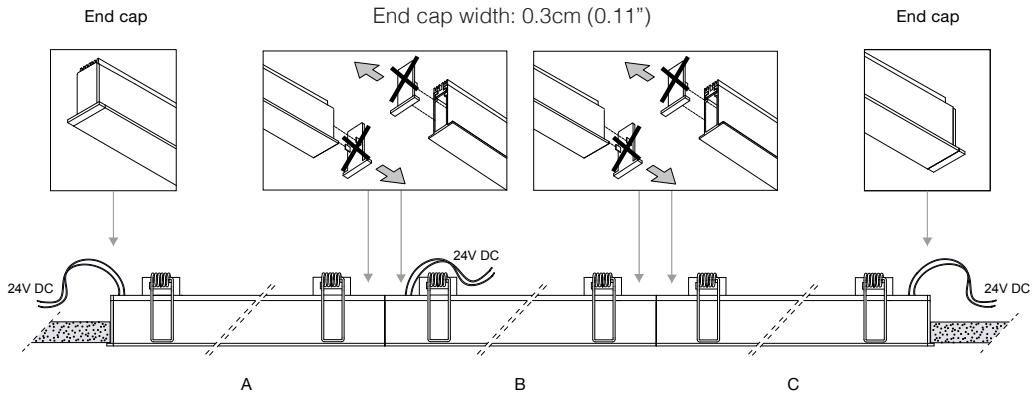

90° angled options are available upon request

SPECIFICATION SHEET

LEDOLOGY®

A **Luminart** BRAND

WWW.LEDOLOGY.COM  
Last updated: 4/12/21